

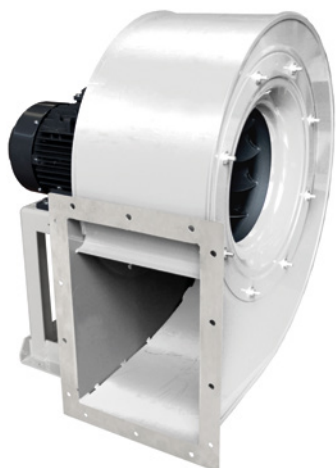

Serie **PDL INOX**



Aspiratori centrifughi pale rovesce
per aria pulita o leggermente polverosa



400 V

IP₅₅

min
-10°C

max
+60°C

CE

IMPIEGO

I ventilatori della serie **PDL INOX** trovano la loro principale applicazione nell'impiantistica industriale e nel condizionamento.

GAMMA

Diametri da 250 a 1.400 mm

Portate da 2.500 a 140.000 m³/h

La serie prevede esecuzioni direttamente accoppiate (esecuzione 4) e a trasmissione (esecuzione 1, 9 e 12).

TEMPERATURA DI ESERCIZIO

Temperature da -10°C a +60°C. A richiesta temperature aria superiori.

COSTRUZIONE

- Cassa a spirale, boccaglio di aspirazione e girante con pale rovesce curve realizzati in acciaio inox AISI 304/316L.
- Per esecuzione 1 – 9 – 12: supporto monoblocco realizzato in fusione di ghisa, con cuscinetti a sfera, progettati per agevolare le operazioni di lubrificazione. Cinghie di trasmissione, pulegge e supporto motore. Carter di protezione per le cinghie.

MOTORE

Motore asincrono trifase a norme internazionali IEC 60034, IEC 60072, EMC 2014/30/UE, LVD 2014/35/UE e marcato CE IP55, classe F, idonei ad un servizio S1 (funzionamento continuo a carico costante).

ACCESSORI

- Controflangia per bocca aspirante
- Controflangia per bocca premente
- Rete di protezione per bocca aspirante
- Rete di protezione per bocca premente
- Giunto antivibrante per bocca aspirante
- Giunto antivibrante per bocca premente

VERSIONI



PDL

Versione per temperatura aria standard da -10 a +60°C



PDL ATEX

Versione antideflagrante secondo la Direttiva 2014/34/UE



PDL AT

Versione idonea al trasporto di gas caldi, max 150°C (PDL/AT es 4) e max 300°C (PDL/AT es 1-12)

CAMPO D'IMPIEGO

Questo grafico ha il solo scopo di rappresentare le aree di funzionamento dei modelli disponibili. Per una selezione precisa utilizzare i grafici prestazionali presenti di seguito oppure contattate il nostro servizio tecnico commerciale.

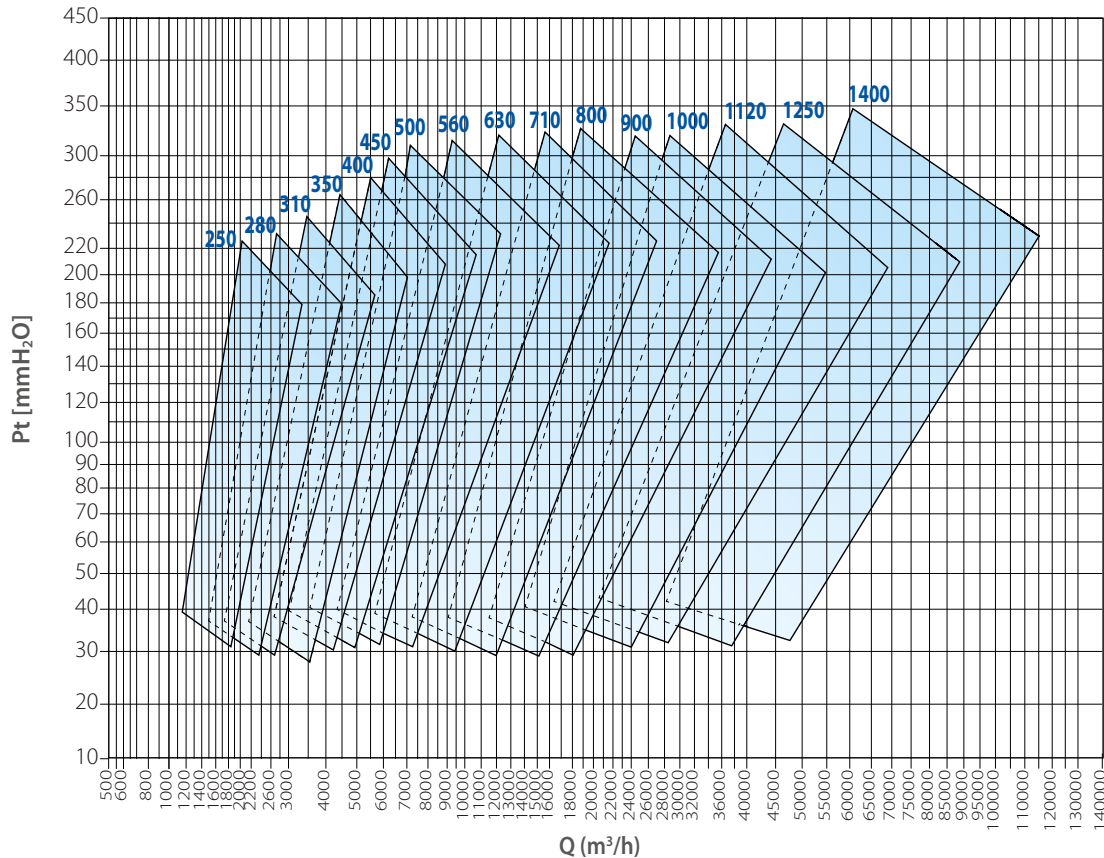

Grandezza entilatore	RPM MAX		
	Classe I	Classe II	Classe III
PDL INOX 250	4000	5000	6000
PDL INOX 280	3800	4500	5300
PDL INOX 310	3600	4100	4750
PDL INOX 350	3250	3700	4250
PDL INOX 400 R	2950	3300	3900
PDL INOX 400	2950	3300	3900
PDL INOX 450 R	2750	3150	3800
PDL INOX 450	2550	2955	3550
PDL INOX 500 R	2350	2750	3350
PDL INOX 500	2250	2600	3150
PDL INOX 560 R	2100	2450	3000
PDL INOX 560	2000	2300	2850
PDL INOX 630 R	1850	2150	2650
PDL INOX 630	1750	2050	2500

Grandezza entilatore	RPM MAX		
	Classe I	Classe II	Classe III
PDL INOX 710 R	1900	2300	2550
PDL INOX 710	1800	2200	2400
PDL INOX 800 R	1700	2050	2300
PDL INOX 800	1600	1950	2150
PDL INOX 900 R	1500	1850	2000
PDL INOX 900	1450	1750	1900
PDL INOX 1000 R	1350	1650	1800
PDL INOX 1000	1250	1550	1700
PDL INOX 1120 R	1250	1350	1450
PDL INOX 1120	1200	1300	1400
PDL INOX 1250 R	1150	1250	1350
PDL INOX 1250	1100	1200	1300
PDL INOX 1400 R	1050	1150	1250
PDL INOX 1400	1000	1100	1200

VALORI RPM VALIDI FINO A 60°C

Fra	E	Declassare velocità
60°C	100°C	4%
100°C	150°C	10%
150°C	200°C	16%
200°C	250°C	23%
250°C	300°C	30%
300°C	350°C	37%
350°C	400°C	45%
400°C	450°C	54%
450°C	500°C	64%

PRESTAZIONI

CODICE	MODELLO	POLI	TENSIONE a 50Hz V	POTENZA kW	CORRENTE ASSORBITA A	MOTERE		PORTATA max (Q) m3/h	PRESSIONE MAX Pa Tot @Q max
						IP/CL	IE3		
A RICHIESTA	PDL INOX 252	2	400	0,55	1,27	55/F	-	2.520	343
A RICHIESTA	PDL INOX 282	2	400	1,10	2,50	55/F	✓	3.600	500
A RICHIESTA	PDL INOX 312	2	400	2,20	4,90	55/F	✓	5.400	647
A RICHIESTA	PDL INOX 314	4	400	0,18	0,60	55/F	-	2.520	137
A RICHIESTA	PDL INOX 352	2	400	3,00	6,40	55/F	✓	7.200	912
A RICHIESTA	PDL INOX 354	4	400	0,37	1,18	55/F	-	3.600	177
A RICHIESTA	PDL INOX 402 R	2	400	4,00	8,00	55/F	✓	6.120	1.716
A RICHIESTA	PDL INOX 402	2	400	5,50	10,80	55/F	✓	10.080	1.206
A RICHIESTA	PDL INOX 404 R	4	400	0,55	1,60	55/F	-	3.960	245
A RICHIESTA	PDL INOX 404	4	400	0,75	2,00	55/F	✓	4.320	216
A RICHIESTA	PDL INOX 452 R	2	400	7,50	14,10	55/F	✓	12.600	1.118
A RICHIESTA	PDL INOX 452	2	400	11,00	20,40	55/F	✓	16.200	1.108
A RICHIESTA	PDL INOX 454 R	4	400	0,75	2,00	55/F	✓	4.680	402
A RICHIESTA	PDL INOX 454	4	400	1,10	2,70	55/F	✓	5.400	510
A RICHIESTA	PDL INOX 502 R	2	400	15,00	27,50	55/F	✓	18.000	1.589
A RICHIESTA	PDL INOX 502	2	400	18,50	33,00	55/F	✓	21.600	1.736
A RICHIESTA	PDL INOX 504 R	4	400	1,50	3,60	55/F	✓	9.000	353
A RICHIESTA	PDL INOX 504	4	400	2,20	5,40	55/F	✓	10.800	373
A RICHIESTA	PDL INOX 506 R	6	400	0,37	1,20	55/F	-	3.600	275
A RICHIESTA	PDL INOX 506	6	400	0,55	1,80	55/F	-	6.120	206
A RICHIESTA	PDL INOX 564 R	4	400	3,00	6,80	55/F	✓	12.600	402
A RICHIESTA	PDL INOX 564	4	400	4,00	8,50	55/F	✓	16.200	343
A RICHIESTA	PDL INOX 566 R	6	400	0,75	2,10	55/F	✓	7.920	177
A RICHIESTA	PDL INOX 566	6	400	1,10	3,50	55/F	✓	9.000	226
A RICHIESTA	PDL INOX 634 R	4	400	5,50	11,30	55/F	✓	19.800	510
A RICHIESTA	PDL INOX 634	4	400	7,50	14,70	55/F	✓	21.600	657
A RICHIESTA	PDL INOX 636 R	6	400	1,50	3,90	55/F	✓	12.600	226
A RICHIESTA	PDL INOX 636	6	400	2,20	5,30	55/F	✓	14.400	245
A RICHIESTA	PDL INOX 714 R	4	400	11,00	22,00	55/F	✓	25.200	804
A RICHIESTA	PDL INOX 714	4	400	15,00	29,00	55/F	✓	32.400	706
A RICHIESTA	PDL INOX 716 R	6	400	3,00	6,60	55/F	✓	16.200	363
A RICHIESTA	PDL INOX 716	6	400	4,00	9,10	55/F	✓	21.600	324
A RICHIESTA	PDL INOX 804 R	4	400	18,50	35,00	55/F	✓	39.600	892
A RICHIESTA	PDL INOX 804	4	400	22,00	41,00	55/F	✓	36.000	1.608
A RICHIESTA	PDL INOX 806 R	6	400	5,50	12,30	55/F	✓	25.200	431
A RICHIESTA	PDL INOX 806	6	400	7,50	15,20	55/F	✓	28.800	431
A RICHIESTA	PDL INOX 904 R	4	400	37,00	68,00	55/F	✓	54.000	1.412
A RICHIESTA	PDL INOX 904	4	400	45,00	80,50	55/F	✓	61.200	1.412
A RICHIESTA	PDL INOX 906 R	6	400	11,00	20,40	55/F	✓	36.000	569
A RICHIESTA	PDL INOX 906	6	400	15,00	29,00	55/F	✓	39.600	657
A RICHIESTA	PDL INOX 1004 R	4	400	55,00	97,61	55/F	✓	54.000	2.863
A RICHIESTA	PDL INOX 1004	4	400	75,00	134,00	55/F	✓	86.400	1.706
A RICHIESTA	PDL1006 R	6	400	18,50	37,50	55/F	✓	46.800	873
A RICHIESTA	PDL INOX 1006	6	400	22,00	42,50	55/F	✓	54.000	843
A RICHIESTA	PDL INOX 1126 R	6	400	30,00	55,62	55/F	✓	68.400	784
A RICHIESTA	PDL INOX 1126	6	400	37,00	68,00	55/F	✓	75.600	1.079
A RICHIESTA	PDL INOX 1256 R	6	400	55,00	96,24	55/F	✓	97.200	1.020
A RICHIESTA	PDL INOX 1256	6	400	75,00	159,67	55/F	✓	108.000	1.285
A RICHIESTA	PDL INOX 1406 R	6	400	90,00	159,97	55/F	✓	122.400	1.579
A RICHIESTA	PDL INOX 1406	6	400	110,00	195,78	55/F	✓	140.000	1.951

CURVE

Le curve prestazionali rappresentate nel presente catalogo sono state ricavate eseguendo prove sui ventilatori in accordo alla normativa ISO 5801 "Metodi di prova e condizioni di accettazione" (che sostituisce la ISO 1053:1995 ed è in accordo con la UNI EN ISO 5801:2009). Per eseguire le prove i ventilatori sono stati installati secondo quanto previsto per la categoria B: con bocca d'aspirazione libera e bocca premente collegata al banco prova. L'efficienza dei ventilatori è conforme all'obiettivo del regolamento (UE)N.327/2011, come richiesto dalla Direttiva 2009/125/CE.

Lw: La determinazione del livello di potenza sonora è stata condotta secondo la norma UNI EN ISO 3746: 1997 (Metodo di controllo con una superficie avvolgente su un piano riflettente). Alle misure sono state applicate correzioni in funzione del rumore di fondo e del riverbero ambientale.

PDL INOX 250-280

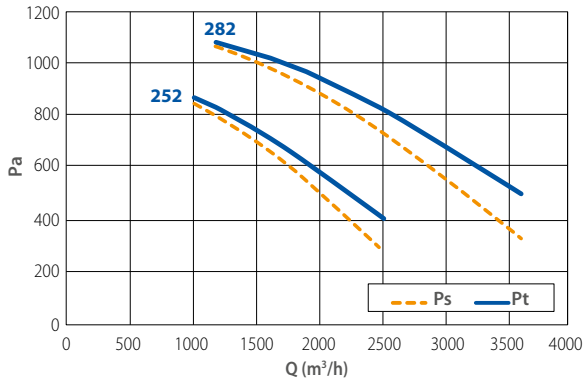

PDL INOX 310

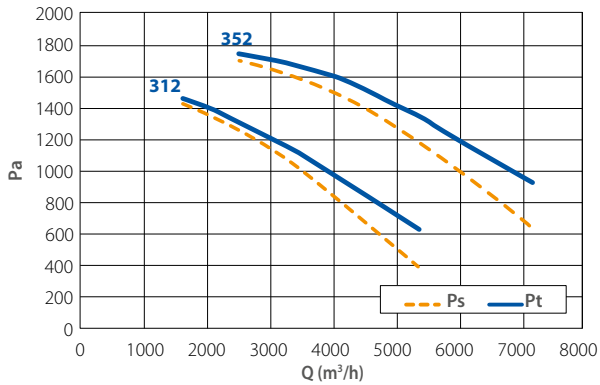

PDL INOX 350

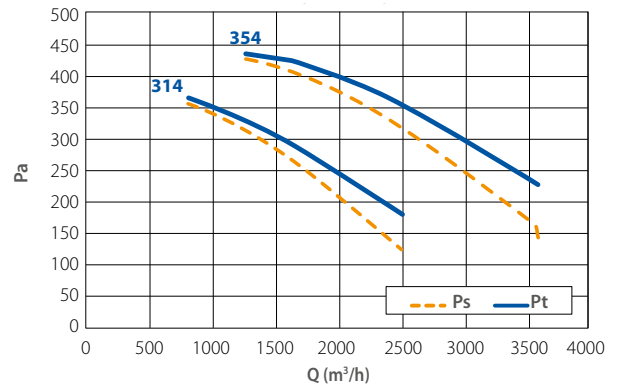

PDL INOX 400

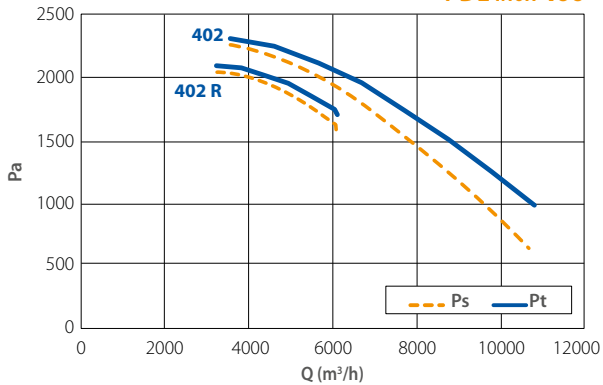

PDL INOX 404

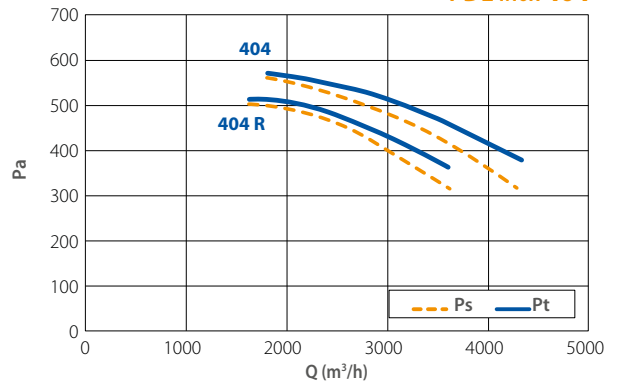

PDL INOX 452

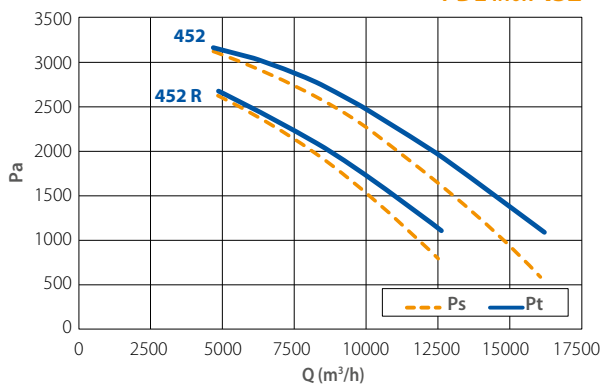

PDL INOX 454

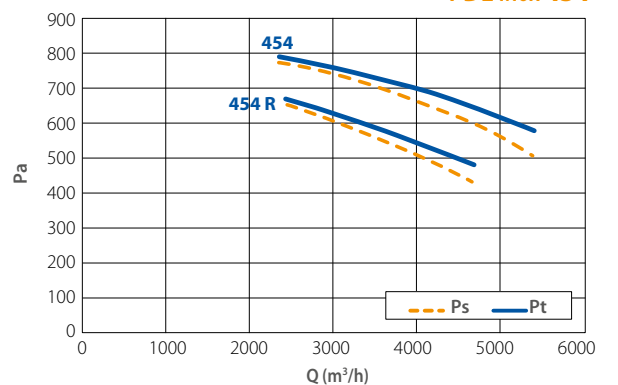

CURVE

PDL INOX 502

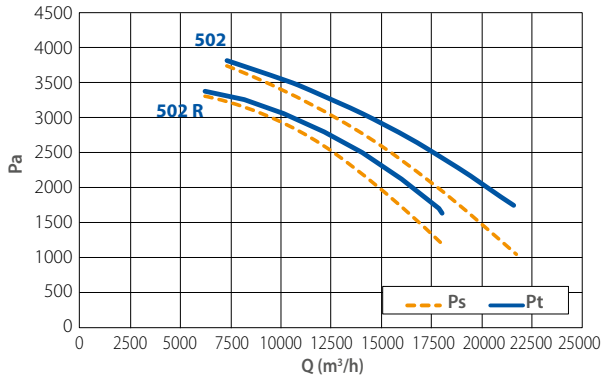

PDL INOX 504

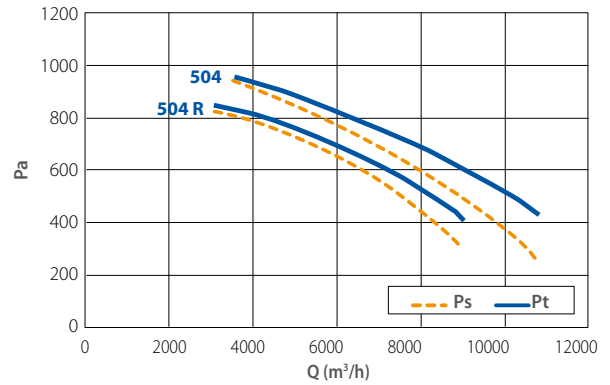

PDL INOX 506

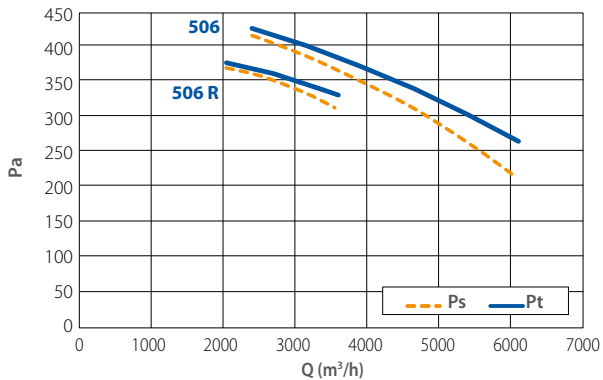

PDL INOX 564

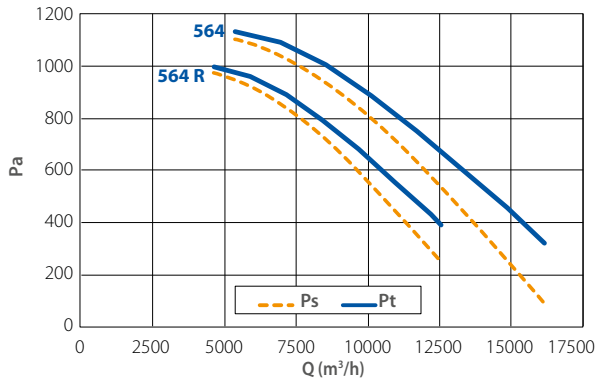

PDL INOX 566

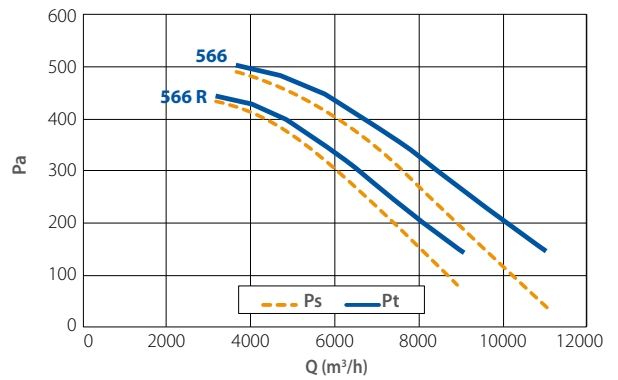

CURVE

PDL INOX 634

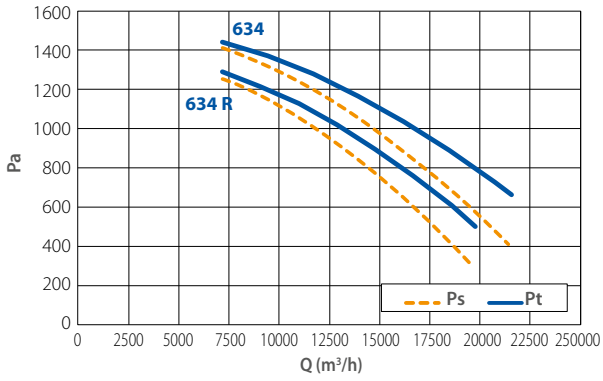

PDL INOX 636

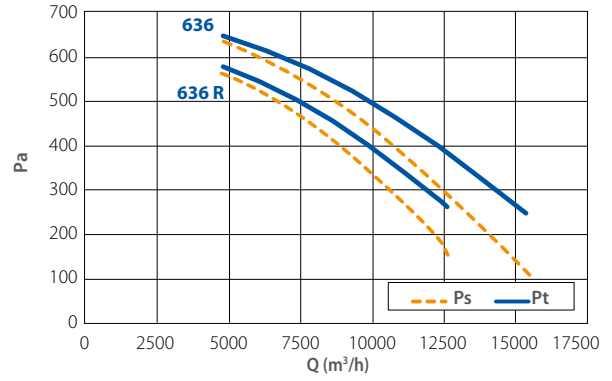

PDL INOX 714

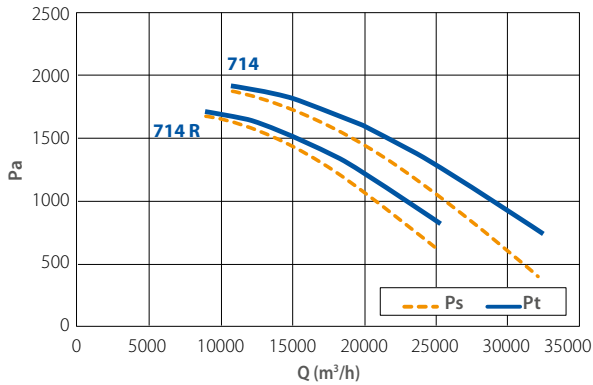

PDL INOX 716

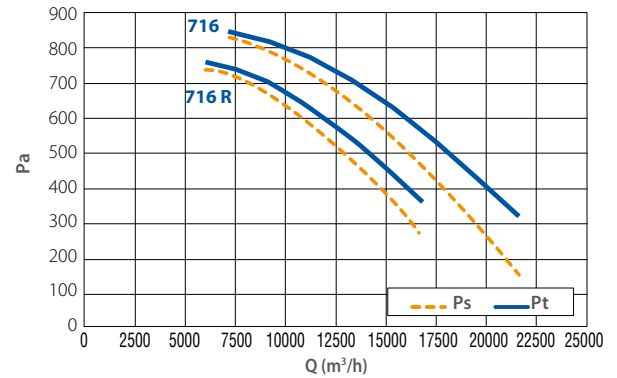

PDL INOX 804

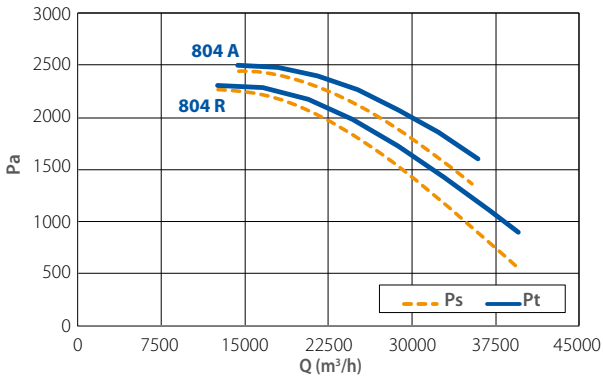

PDL INOX 806

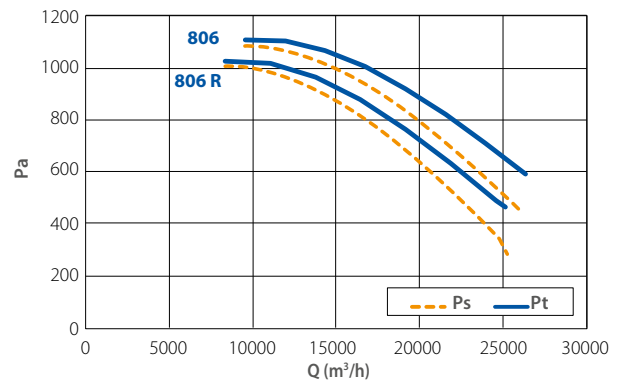

CURVE

PDL INOX 904

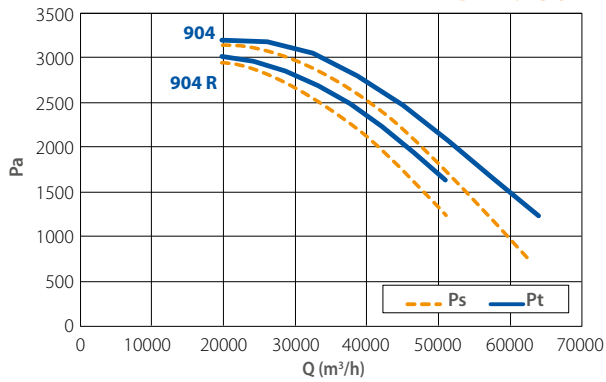

PDL INOX 906

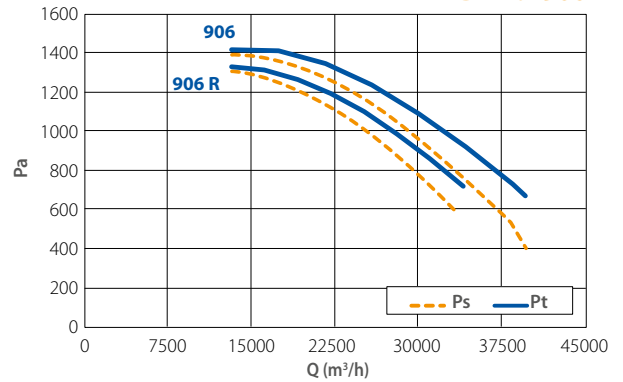

PDL INOX 1004

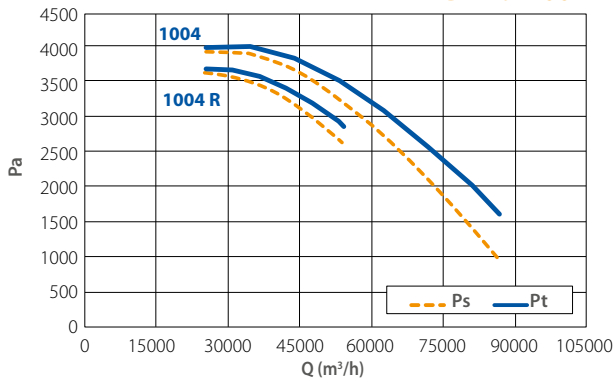

PDL INOX 1006

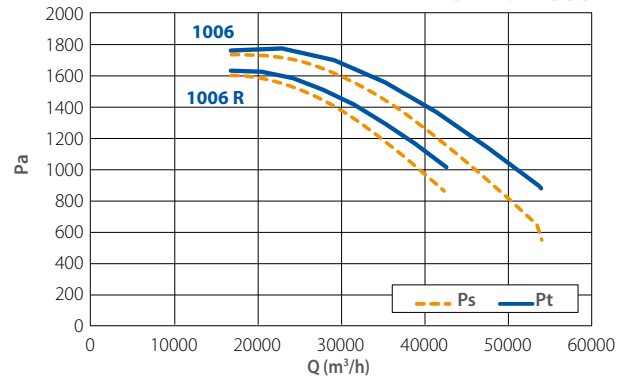

PDL INOX 1120

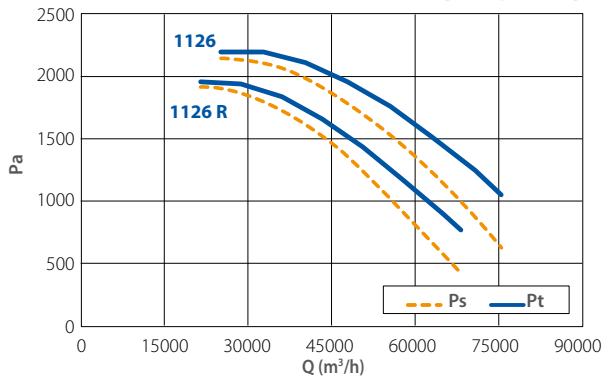

PDL INOX 1250

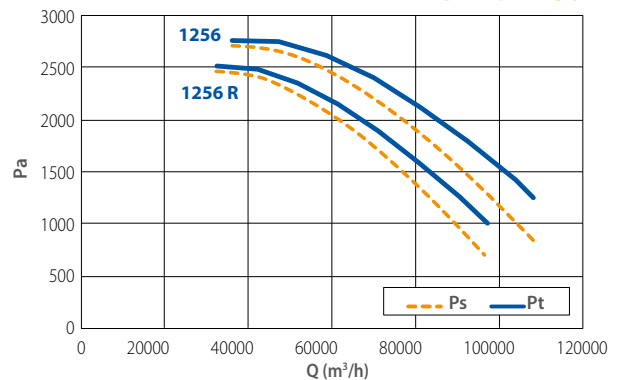

PDL INOX 1400

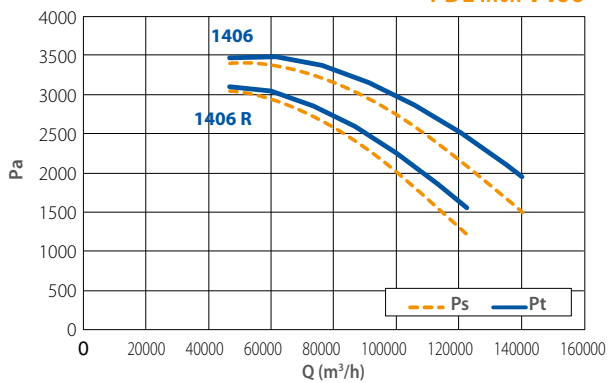

DIMENSIONI (mm)

ESECUZIONE 1

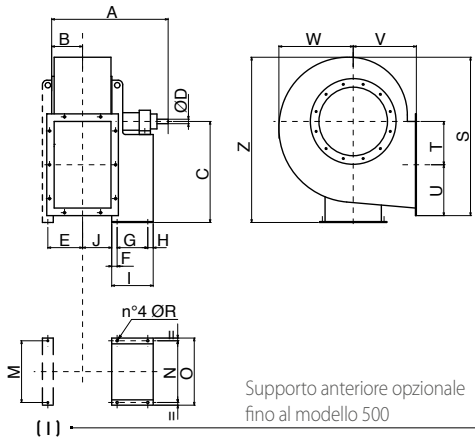

TIPO	A	B	C	ØD	E	F	G	H	I	J	M	N	O	ØR	S	T	U	V	W	Z
PDL INOX 250	550	94	315	19	110	55	210	17	282	96	280	228	255	10	525	149	164	195	276	527
PDL INOX 280	655	105	375	24	123	40	284	23	347	105	315	288	324	12	586	172	184	200	305	605
PDL INOX 310	680	117	400	24	135	40	284	23	347	117	350	288	324	12	653	196	201	225	332	656
PDL INOX 350	860	130	450	28	153	50	407	28	485	131	395	355	400	14	725	216	221	255	375	738
PDL INOX 400	910	147	500	38	174	50	407	28	485	147	445	355	400	14	798	245	242	285	400	811
PDL INOX 450	930	163	560	38	191	50	407	28	485	165	495	355	400	14	895	275	267	320	445	913
PDL INOX 500	1084	183	600	42	211	50	477	33	560	185	545	364	418	17	997	303	294	360	502	1000

ESECUZIONE 1

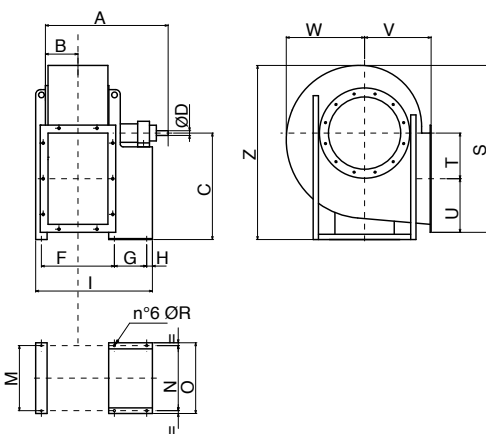

TIPO	A	B	C	ØD	F	G	H	I	M	N	O	ØR	S	T	U	V	W	Z
PDL INOX 560	1177	205	670	48	468	477	33	1021	632	632	692	17	1151	332	335	400	570	1154
PDL INOX 630	1233	230	750	48	527	477	33	1070	702	702	762	17	1282	373	369	450	630	1290
PDL INOX 710	1340	257	850	48	600	551	39	1217	772	772	826	19	1402	427	408	500	690	1417
PDL INOX 800	1422	287	950	55	662	551	39	1299	862	862	926	19	1590	478	461	560	782	1601
PDL INOX 900	1491	322	1060	55	731	551	39	1368	962	962	1026	19	1770	538	509	630	870	1783
PDL INOX 1000	1710	360	1180	65	803	607	45	1522	1056	1056	1128	19	1985	607	564	710	976	1994
PDL INOX 1120	1941	404	1320	75	926	760	45	1786	1178	1178	1268	24	2251	684	635	800	1084	2252
PDL INOX 1250	2038	452	1500	75	1023	760	45	1883	1310	1310	1400	24	2521	770	704	900	1214	2547
PDL INOX 1400	2252	507	1700	80	1152	780	55	2072	1450	1450	1560	24	2770	854	781	1000	1325	2835

BOCCA ASPIRANTE

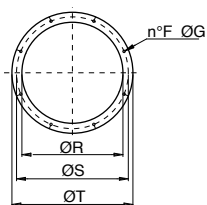

TIPO	ØR	ØS	ØT	n°F	ØG
PDL INOX 250	255	292	325	8	10
PDL INOX 280	285	332	365	8	12
PDL INOX 310	320	366	400	8	12
PDL INOX 350	360	405	440	8	12
PDL INOX 400	405	448	485	12	12
PDL INOX 450	455	497	535	12	12
PDL INOX 500	505	551	585	12	14
PDL INOX 560	565	629	665	12	14
PDL INOX 630	635	698	735	12	14
PDL INOX 710	715	775	815	16	14
PDL INOX 800	805	861	905	16	14
PDL INOX 900	905	958	1005	16	14
PDL INOX 1000	1007	1067	1107	24	14
PDL INOX 1120	1130	1200	1250	24	14
PDL INOX 1250	1260	1337	1380	24	17
PDL INOX 1400	1420	1491	1540	32	17

BOCCA PREMENTE

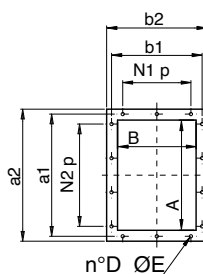

TIPO	A	B	a1	b1	a2	b2	N1 x p	N2 x p	n°D	ØE
PDL INOX 250	258	185	292	219	328	255	1x112	2x112	10	12
PDL INOX 280	288	205	332	249	368	285	1x125	2x125	10	12
PDL INOX 310	322	229	366	273	402	309	1x125	2x125	10	12
PDL INOX 350	361	256	405	300	441	336	1x125	2x125	10	12
PDL INOX 400	404	288	448	332	484	368	2x125	3x125	14	12
PDL INOX 450	453	322	497	366	533	402	2x125	3x125	14	12
PDL INOX 500	507	361	551	405	587	441	2x125	3x125	14	12
PDL INOX 560	569	404	629	464	669	504	2x160	3x160	14	14
PDL INOX 630	638	453	698	513	738	553	2x160	3x160	14	14
PDL INOX 710	715	507	775	567	815	607	2x160	4x160	16	14
PDL INOX 800	801	569	871	639	921	689	2x200	3x200	14	14
PDL INOX 900	898	638	968	708	1018	758	3x200	4x200	18	14
PDL INOX 1000	1007	715	1077	785	1127	835	3x200	4x200	18	14
PDL INOX 1120	1130	801	1210	881	1270	941	3x200	5x200	20	18
PDL INOX 1250	1267	898	1347	978	1407	1038	4x200	6x200	24	18
PDL INOX 1400	1421	1007	1501	1087	1561	1147	4x200	6x200	24	18

DIMENSIONI (mm) E ORIENTAMENTI

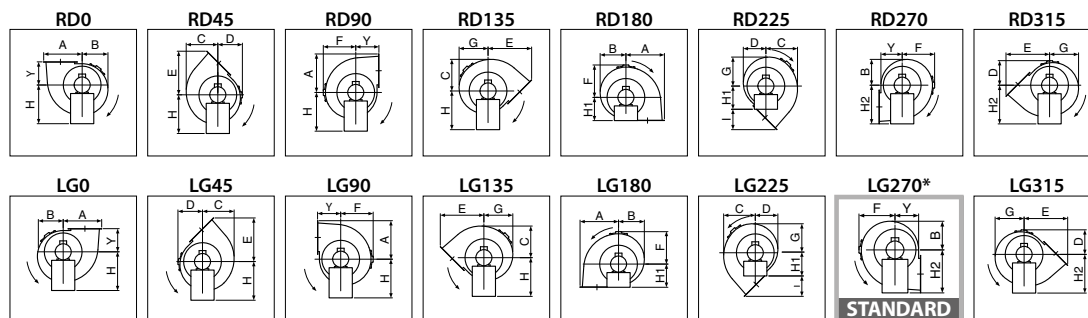

* Versione standard

Dimensioni dei modelli secondo l'orientamento.

TIPO	A	B	C	D	E	F	G	I	Y	H	H1	H2
PDL INOX 250	313	212	255	215	359	276	235	164	195	315	195	315
PDL INOX 280	356	230	287	226	393	305	262	193	200	375	200	375
PDL INOX 310	397	256	316	253	440	332	288	215	225	400	225	400
PDL INOX 350	437	289	359	278	492	375	325	237	255	450	255	450
PDL INOX 400	487	311	387	306	543	400	353	258	285	500	285	500
PDL INOX 450	542	354	435	342	609	445	398	289	320	560	320	560
PDL INOX 500	597	401	490	380	676	502	450	316	360	600	360	600
PDL INOX 560	667	485	555	425	754	570	542	354	400	670	400	670
PDL INOX 630	742	540	619	476	843	630	603	393	450	750	450	750
PDL INOX 710	835	568	719	497	944	690	662	444	500	850	500	850
PDL INOX 800	939	652	811	562	1061	782	749	501	560	950	560	950
PDL INOX 900	1047	723	905	633	1186	870	835	556	630	850	630	1060
PDL INOX 1000	1171	815	1015	718	1330	976	936	620	710	950	710	1180
PDL INOX 1120	1319	932	1132	793	1498	1084	1037	698	800	1060	800	1320
PDL INOX 1250	1474	1048	1270	898	1679	1214	1163	779	900	1190	900	1500
PDL INOX 1400	1635	1136	1395	990	1863	1325	1272	863	1000	1320	1000	1700

PESI

MODELLO	Kg*	MODELLO	Kg*	MODELLO	Kg*	MODELLO	Kg*	MODELLO	Kg*	MODELLO	Kg*
PDL INOX 252	37	PDL INOX 404	75	PDL INOX 506 R	115	PDL INOX 636	180	PDL INOX 904 R	840	PDL INOX 1126	1242
PDL INOX 282	45	PDL INOX 452 R	124	PDL INOX 506	117	PDL INOX 714 R	315	PDL INOX 904	847	PDL INOX 1256 R	1739
PDL INOX 312	57	PDL INOX 452	161	PDL INOX 564 R	153	PDL INOX 714	315	PDL INOX 906 R	556	PDL INOX 1256	1980
PDL INOX 314	43	PDL INOX 454 R	89	PDL INOX 564	158	PDL INOX 716 R	276	PDL INOX 906	658	PDL INOX 1406 R	2630
PDL INOX 352	80	PDL INOX 454	94	PDL INOX 566 R	141	PDL INOX 716	276	PDL INOX 1004 R	1105	PDL INOX 1406	2651
PDL INOX 354	65	PDL INOX 502 R	187	PDL INOX 566	145	PDL INOX 804 R	465	PDL INOX 1004	1278		
PDL INOX 402 R	95	PDL INOX 502	196	PDL INOX 634 R	202	PDL INOX 804	465	PDL INOX 1006 R	879		
PDL INOX 402	116	PDL INOX 504 R	123	PDL INOX 634	214	PDL INOX 806 R	367	PDL INOX 1006	885		
PDL INOX 404 R	75	PDL INOX 504	130	PDL INOX 636 R	173	PDL INOX 806	367	PDL INOX 1126 R	1153		

* Pesì indicativi



LATO ASPIRANTE Flangia - Rete - Giunto

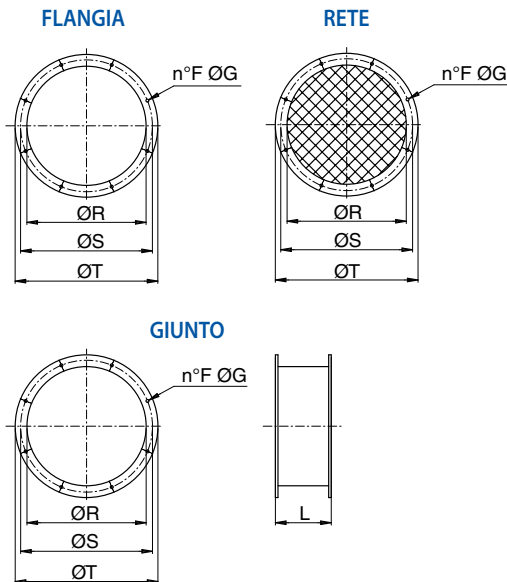

Flangia	Rete	Giunto	Tipo	ØR	ØS	ØT	F	ØG	L
5B01323	5RE4050	5SU1096	250	255	292	325	8	10	145
5B01364	5RE1027	5SU3147	250	285	332	365	8	12	145
5B01334	5RE1002	5SU3101	310	320	366	400	8	12	145
5B01330	5RE1022	5SU3500	350	360	405	440	8	12	145
5B01347	5RE5606	5SU1102	400	405	448	485	12	12	145
5B08105	5RE1046	5SU1406	450	455	497	535	12	12	145
5B01380	5RE1180	5SU1180	500	505	551	585	12	14	180
5B08087	5RE1016	5SU8004	560	565	629	665	12	14	180
5B01391	5RE1013	5SU9000	630	635	698	735	12	14	180
5B08101	5RE1015	5SU1100	710	715	775	815	16	14	180
5B01357	5RE0815	5SU8000	800	805	861	905	16	14	180
5B01359	5RE0090	5SU9002	900	905	958	1005	16	14	230
5B01408	5RE1010	5SU1144	1000	1007	1067	1107	24	14	230
5B01398	5RE1011	5SU1145	1120	1130	1200	1250	24	14	230
5B01409	5RE1014	5SU1146	1250	1260	1337	1380	24	17	230
5B01404	5RE1012	5SU3077	1400	1420	1491	1540	32	17	230

Dimensioni in mm

LATO PREMENTE Flangia - Rete - Giunto

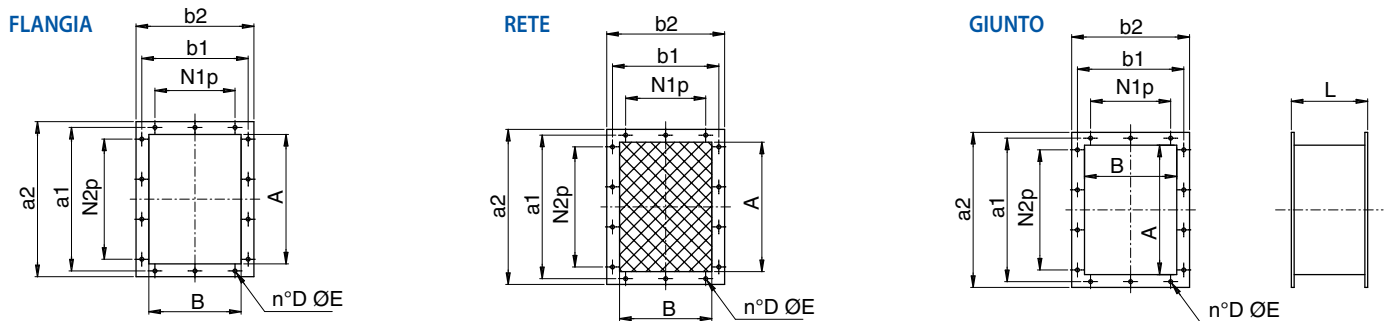

Flangia	Rete	Giunto	Tipo	A	B	a1	b1	a2	b2	N1 xp	N2 xp	n°D	øE	L
5B01324	5RE3138	5SU3138	250	258	185	292	219	328	255	1 x 112	2 x 112	10	12	145
5B01365	5RE1130	5SU1130	250	288	205	332	249	368	285	1 x 125	2 x 125	10	12	145
5B01362	5RE1348	5SU3148	310	322	229	366	273	402	309	1 x 125	2 x 125	10	12	145
5B01340	5RE1023	5SU3501	350	361	256	405	300	441	336	1 x 125	2 x 125	10	12	145
5B01344	5RE1020	5SU4023	400	404	288	448	332	484	368	2 x 125	3 x 125	14	12	145
5B01348	5RE1006	5SU5601	450	453	322	497	366	533	402	2 x 125	3 x 125	14	12	145
5B01381	5RE1024	5SU1181	500	507	361	551	405	587	441	2 x 125	3 x 125	14	12	145
5B08104	5RE1004	5SU4021	560	569	404	629	464	669	504	2 x 160	3 x 160	14	14	180
5B01310	5RE1035	5SU1402	630	638	453	698	513	738	553	2 x 160	3 x 160	14	14	180
5B01390	5RE1009	5SU1101	710	715	507	775	567	815	607	2 x 160	4 x 160	16	14	180
5B01392	5RE3079	5SU3079	800	801	569	871	639	921	689	2 x 200	3 x 200	14	14	180
5B01360	5RE9003	5SU9003	900	898	638	968	708	1018	758	3 x 200	4 x 200	18	14	180
5B08100	5RE1128	5SU1128	1000	1007	715	1077	785	1127	835	3 x 200	4 x 200	18	14	180
5B01399	5RE1399	5SU1399	1120	1130	801	1210	881	1270	941	3 x 200	5 x 200	20	18	180
5B01413	5RE1413	5SU1413	1250	1267	898	1347	978	1407	1038	4 x 200	6 x 200	24	18	180
5B01405	5RE3078	5SU3078	1400	1421	1007	1501	1087	1561	1147	4 x 200	6 x 200	24	18	180

Dimensioni in mm